

hp-32f VESA adapter

Assembly instructions

The 3idee VESA adapter is compatible with the following product from (hp.com) compatible:

32f

With the VESA adapter, you can conveniently attach your HP brand monitor to a monitor arm with a VESA hole pattern (**75 x 75mm**). Use the included screws and nuts.

If you want to mount your VESA adapter directly to the wall, use suitable screws and dowels (**not included**).



Important Safeguards



Please read these instructions carefully and keep them for future reference. If you pass the product on to third parties, these instructions should always be included. Failure to follow these instructions may result in injury or damage to persons or the product, for which we cannot accept any liability.

IMPORTANT - KEEP FOR FUTURE REFERENCE.

- This product should always be used in accordance with the specified safety instructions.
- Do not install your VESA adapter in combination with the monitor in places where there are people below.
- Do not exceed the maximum weight of the compatible monitor models as this may result in serious injury or damage to property.
- Observe the maximum ambient temperature of 35°C when using the product.
- Do not mount the VESA adapter near a heat source or in direct sunlight, as this could heat up the adapter.
- Check whether your mounting point (e.g. monitor arm) can withstand the weight of the monitor with VESA adapter.
- The product is designed exclusively for mounting with a hole pattern of 75x75 mm.
- After installing the VESA adapter, the position of the monitor must be readjusted to ensure correct ergonomics.

CAUTION

Ensure that the device is switched off and disconnected from the power supply before installation to avoid possible injury or damage.

1. Before First Use

Check the product carefully for possible transport damage and for the absence of accessories, such as screws, which should be included in the scope of delivery.

CAUTION

Make sure that packaging materials and small screws and parts contained therein are inaccessible to children to minimize the risk of choking and other risks.

2. Maintenance and Cleaning

2.1 Maintenance

- It is recommended to check every three months that all screws are still tight. Also, regularly check the condition of all components of the product.
- Store the product in a cool and safe place, ideally at a maximum storage temperature of 40°C. For additional safety, keep the product away from children and preferably in its original packaging.
- Avoid any vibrations and shocks so as not to affect the life and functionality of the product.

2.2 Cleaning

- No corrosive or hot cleaning agents should be used to clean the product. Likewise, wire brushes, metal or other sharp materials are unsuitable for cleaning and should not be used.
- For gentle and effective cleaning, the use of a soft, damp cloth is recommended.

3. Waste Disposal

For the disposal of this product we recommend to contact the responsible local authorities or disposal services. They can provide you with detailed information on available disposal options and recycling centers in your area.

4. Manufacturer Information

3idee Technologies S.à r.l.
5 Um Lenster Bierg
L-6125 Junglinster
Luxembourg

5. Help and Feedback

If you need help with your article, we are here for you. We also appreciate any feedback.

<https://help.3idee.eu/en/contact>

Scope of Delivery Accessories



**4x M4x14 screw with cross recess
(SP5 or SP1)**



4x M4 lock nut (SP5 or SP1)

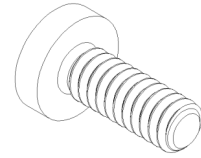

**2x M3x8 screw with cross recess
(SP5)**

Horizontal / Vertical Alignment

Please note: Not all VESA adapters and monitors are designed for vertical (upright) orientation. This limitation is often due to the specific geometry of the adapter or monitor. Do not ignore this information, as the load limit of the adapter can quickly be exceeded if not installed properly.

We are continuously working on developing monitors and adapters that are also suitable for vertical orientation.

However, monitors are designed for horizontal alignment by default.

**Horizontal
Mounting: YES**



**Vertical
Mounting: NO**



Assembly Instruction

Step 1

Place your screen in a safe, soft place so that your screen does not get damaged.

Remove the base of the monitor.

Step 2

Loosen the two screws on the bottom of the white clip. Then you can pull it off the monitor. (Figure 1)

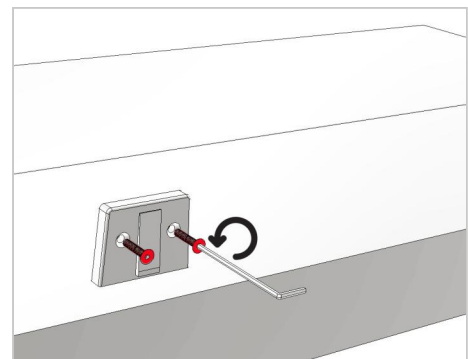

Figure 1

Step 3

⚠ Important: If the instructions in this step are not suitable for your device, please follow the mounting guidelines of the manufacturer of your monitor arm or swivel arm to mount the monitor to the wall or swivel arm.

The preparation is complete, now you can attach the 3idee Vesa adapter to your monitor arm / wall. Use the provided **screws** and **nuts** . (Figure 2)

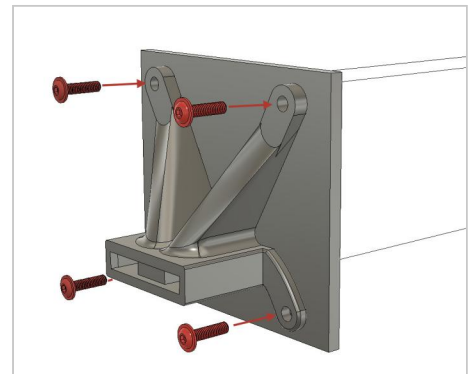

Figure 2

Step 4

For this step, it is best to have a second person help you. Now take your monitor and carefully insert it into the mount (Figure 3). **Hold the monitor firmly while it is not yet fixed to the mount with the 2 screws.**

The screw holes in the Vesa adapter should now be aligned with the threads in the metal part of the monitor.

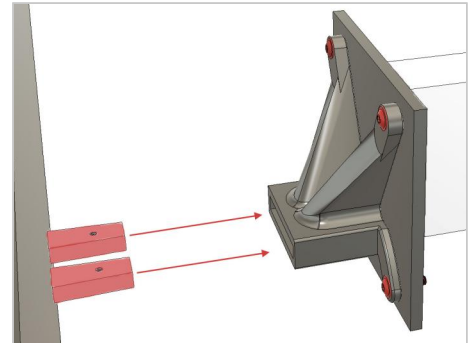

Figure 3

Step 5

Now screw the 2 small screws (**SP5**) into the Vesa adapter from below until they are flush and firmly screwed to the monitor. (Figure 4)

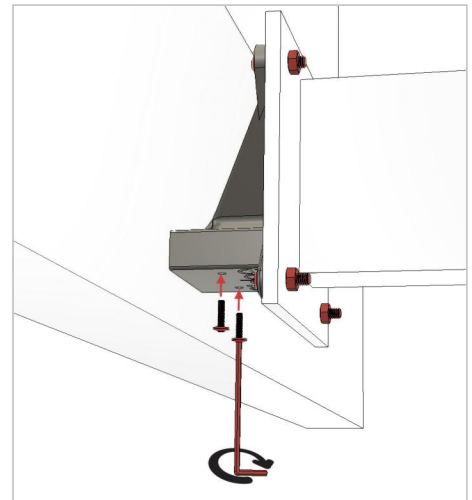

Figure 4